

ENG

Instructions for Use:  
**HUMAN ANGPTL7 ELISA**

Catalogue number:  
**REH003R**

**For research use only!**

 **BioVendor**  
**R&D**<sup>®</sup>



**BioVendor – Laboratorní medicína a.s.**

Karásek 1767/1, 621 00 Brno, Czech Republic

+420 549 124 185

[info@biovendor.com](mailto:info@biovendor.com)

[sales@biovendor.com](mailto:sales@biovendor.com)

[www.biovendor.com](http://www.biovendor.com)

1. INTRODUCTION	3
2. STORAGE, EXPIRATION	3
3. REAGENT SUPPLIED	3
4. MATERIAL REQUIRED BUT NOT SUPPLIED	4
5. PREPARATION OF REAGENTS	4
6. ASSAY PROCEDURE	5
7. ASSAY PROCEDURE - SUMMARY	5
8. CALCULATIONS	6
9. TROUBLESHOOTING	7
10. EXPLANATION OF SYMBOLS	8

## HISTORY OF CHANGES

Previous version	Current version
	ENG.001.A
New edition	

### 1. INTRODUCTION

The BioVendor Human ANGPTL7 ELISA kit is an in vitro enzyme-linked immunosorbent assay for the quantitative measurement of human ANGPTL7 in serum, plasma and cell culture supernatants. This assay employs an antibody specific for human ANGPTL7 coated on a 96well plate. Standards and samples are pipetted into the wells and ANGPTL7 present in a sample is bound to the wells by the immobilized antibody. The wells are washed and biotinylated anti-human ANGPTL7 antibody is added. After washing away unbound biotinylated antibody, HRP-conjugated streptavidin is pipetted to the wells. The wells are again washed, a TMB substrate solution is added to the wells and color develops in proportion to the amount of ANGPTL7 bound. The Stop Solution changes the color from blue to yellow, and the intensity of the color is measured at 450 nm.

### 2. STORAGE, EXPIRATION

The kit may be stored at 4°C for up to 6 months. For extended storage, it is recommended to store at -80°C. For prepared reagent storage, see table below.

### 3. REAGENT SUPPLIED

Component	Size / Description	Storage / Stability After Preparation
ANGPTL7 Microplate (Item A)	96 wells (12 strips x 8 wells) coated with anti-Human ANGPTL7	1 month at 4 °C*
Wash Buffer Concentrate (20X) (Item B)	25 ml of 20X concentrated solution	1 month at 4 °C
Standard Protein (Item C)	2 vials of Human ANGPTL7. 1 vial is enough to run each standard in duplicate	1 week at -80 °C
Detection Antibody ANGPTL7 (Item F)	2 vials of biotinylated anti-Human ANGPTL7. Each vial is enough to assay half the microplate	5 days at 4 °C
HRP-Streptavidin Concentrate (Item G)	200 µl 200X concentrated HRP-conjugated streptavidin	Do not store and reuse
TMB One-Step Substrate Reagent (Item H)	12 ml of 3,3',5,5'-tetramethylbenzidine (TMB) in buffer solution	N/A
Stop Solution (Item I)	8 ml of 0.2 M sulfuric acid	N/A
Assay Diluent (Item E2)	15ml of 5X concentrated buffer	1 month at 4 °C

\*Return unused wells to the pouch containing desiccant pack, reseal along entire edge.

#### 4. MATERIAL REQUIRED BUT NOT SUPPLIED

- Microplate reader capable of measuring absorbance at 450 nm.
- Precision pipettes to deliver 2 µl to 1 ml volumes.
- Adjustable 1-25 ml pipettes for reagent preparation.
- 100 ml and 1 liter graduated cylinders.
- Absorbent paper.
- Distilled or deionized water.
- Log-log graph paper or computer and software for ELISA data analysis.
- Tubes to prepare standard or sample dilutions.

#### 5. PREPARATION OF REAGENTS

1. Bring all reagents and samples to room temperature (18 - 25°C) before use.
2. Assay Diluent (Item E2) should be diluted 5-fold with deionized or distilled water before use.
3. Sample dilution: 1X Assay Diluent (Item E2) should be used for dilution of serum, plasma, and cell culture supernatant samples. The suggested dilution for normal serum/plasma is 2 fold.

**Note:** Levels of ANGPTL7 may vary between different samples. Optimal dilution factors for each sample must be determined by the investigator.

4. Preparation of standard: Briefly spin a vial of Item C. Add 833.3 µl 1X Assay Diluent (Item E2, Assay Diluent should be diluted 5-fold with deionized or distilled water before use) into Item C vial to prepare a 12 ng/ml standard solution. Dissolve the powder thoroughly by a gentle mix. Pipette 300 µl 1X Assay Diluent into each tube. Use the 12 ng/ml standard solution to produce a dilution series (shown below). Mix each tube thoroughly before the next transfer. 1X Assay Diluent serves as the zero standard (0 ng/ml)

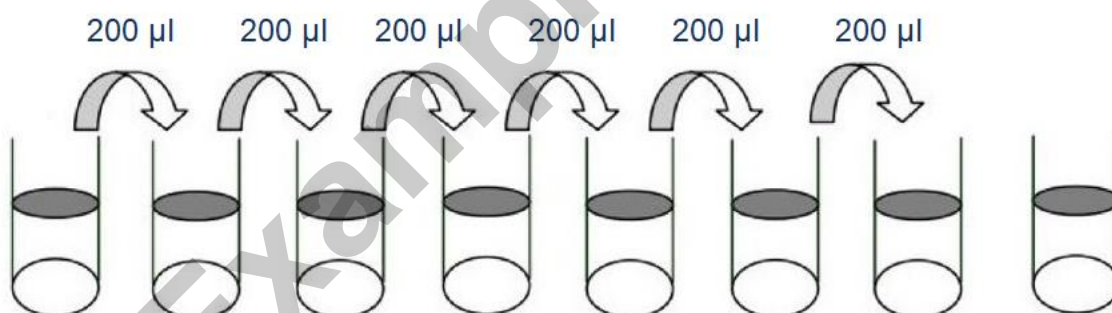

	Std1	Std2	Std3	Std4	Std5	Std6	Std7	Zero Standard
<b>Diluent volume</b>	ItemC +833.3 µl	300 µl	300 µl	300 µl	300 µl	300 µl	300 µl	300 µl
<b>Conc.</b>	12 ng/ml	4.800 ng/ml	1.920 ng/ml	0.768 ng/ml	0.307 ng/ml	0.123 ng/ml	0.049 ng/ml	0 ng/ml

5. If the Wash Concentrate (20X) (Item B) contains visible crystals, warm to room temperature and mix gently until dissolved. Dilute 20 ml of Wash Buffer Concentrate into deionized or distilled water to yield 400 ml of 1X Wash Buffer.
6. Briefly spin the Detection Antibody vial (Item F) before use. Add 100  $\mu$ l of 1X Assay Diluent (Item E2) into the vial to prepare a detection antibody concentrate. Pipette up and down to mix gently (the concentrate can be stored at 4°C for 5 days). The detection antibody concentrate should be diluted 80-fold with 1X Assay Diluent (Item E2) and used in step 5 of Part VI Assay Procedure.
7. Briefly spin the HRP-Streptavidin concentrate vial (Item G) and pipette up and down to mix gently before use, as precipitates may form during storage. HRP-Streptavidin concentrate should be diluted 200-fold with 1X Assay Diluent (Item E2).

For example: Briefly spin the vial (Item G) and pipette up and down to mix gently. Add 50  $\mu$ l of HRP-Streptavidin concentrate into a tube with 10 ml 1x Assay Diluent to prepare a 200-fold diluted HRP-Streptavidin solution (don't store the diluted solution for next day use). Mix well.

## 6. ASSAY PROCEDURE

1. Bring all reagents and samples to room temperature (18 - 25°C) before use. It is recommended that all standards and samples be run at least in duplicate.
2. Label removable 8-well strips as appropriate for your experiment.
3. Add 100  $\mu$ l of each standard (see Reagent Preparation step 3) and sample into appropriate wells. Cover wells and incubate for 2.5 hours at room temperature with gentle shaking.
4. Discard the solution and wash 4 times with 1X Wash Solution. Wash by filling each well with Wash Buffer (300  $\mu$ l) using a multi-channel Pipette or autowasher. Complete removal of liquid at each step is essential to good performance. After the last wash, remove any remaining Wash Buffer by aspirating or decanting. Invert the plate and blot it against clean paper towels.
5. Add 100  $\mu$ l of 1X prepared biotinylated antibody (Reagent Preparation step 6) to each well. Incubate for 1 hour at room temperature with gentle shaking.
6. Discard the solution. Repeat the wash as in step 4.
7. Add 100  $\mu$ l of prepared Streptavidin solution (see Reagent Preparation step 7) to each well. Incubate for 45 minutes at room temperature with gentle shaking.
8. Discard the solution. Repeat the wash as in step 4.
9. Add 100  $\mu$ l of TMB One-Step Substrate Reagent (Item H) to each well. Incubate for 30 minutes at room temperature in the dark with gentle shaking.
10. Add 50  $\mu$ l of Stop Solution (Item I) to each well. Read at 450 nm immediately.

## 7. ASSAY PROCEDURE - SUMMARY

1. Prepare all reagents, samples and standards as instructed.
2. Add 100  $\mu$ l standard or sample to each well. Incubate 2.5 hours at room temperature.
3. Add 100  $\mu$ l prepared biotin antibody to each well. Incubate 1 hour at room temperature.
4. Add 100  $\mu$ l prepared Streptavidin solution. Incubate 45 minutes at room temperature.
5. Add 100  $\mu$ l TMB One-Step Substrate Reagent to each well. Incubate 30 minutes at room temperature.
6. Add 50  $\mu$ l Stop Solution to each well. Read at 450 nm immediately.

## 8. CALCULATIONS

Calculate the mean absorbance for each set of duplicate standards, controls and samples, and subtract the average zero standard optical density. Plot the standard curve on log-log graph paper or using Sigma plot software, with standard concentration on the x-axis and absorbance on the y-axis. Draw the best-fit straight line through the standard points.

### 8.1 TYPICAL DATA

These standard curves are for demonstration only. A standard curve must be run with each assay.

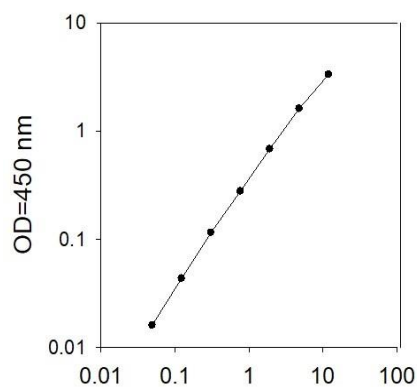

Human ANGPTL7 concentration (ng/ml)

### 8.2 SENSITIVITY

The minimum detectable dose of Human ANGPTL7 was determined to be 0.05 ng/ml. Minimum detectable dose is defined as the analyte concentration resulting in an absorbance that is 2 standard deviations higher than that of the blank (diluent buffer).

### 8.3 SPIKING & RECOVERY

Recovery was determined by spiking various levels of Human ANGPTL7 into the sample types listed below. Mean recoveries are as follows:

Sample Type	Average % Recovery	Range (%)
Serum	98.37	80-119
Plasma	85.93	71-117
Cell culture media	105.1	97-117

### 8.4 LINEARITY

Sample Type		Serum	Plasma	Cell Culture Media
1:2	Average % of Expected	87.92	83.31	107.0
	Range (%)	78-98	81-86	101-113
1:4	Average % of Expected	89.35	109.7	118.0
	Range (%)	68-98	100-118	105-131

### 8.5 REPRODUCIBILITY

Intra-Assay CV%: <10%

Inter-Assay CV%: <12%

## 8.6 SPECIFICITY









This ELISA antibody pair detects human ANGPTL7. Other species not determined

## 9. TROUBLESHOOTING

Problem	Cause	Solution
Poor standard curve	Inaccurate pipetting	Check pipettes
	Improper standard dilution	Briefly centrifuge Item C and dissolve the powder thoroughly by gently mixing
Low signal	Improper preparation of standard and/or biotinylated antibody	Briefly spin down before opening. Dissolve the powder thoroughly.
	Too brief incubation times	Ensure sufficient incubation time. Assay procedure step 3 may be done overnight at 4 °C with gentle shaking (note: may increase overall signals including background)
	Inadequate reagent volumes or improper dilution	Check pipettes and ensure correct preparation
Large CV	Inaccurate pipetting	Check pipettes
	Air bubbles in wells	Remove bubbles in wells
High background	Plate is insufficiently washed	Review the manual for proper wash. If using a plate washer, ensure that all ports are unobstructed
	Contaminated wash buffer	Make fresh wash buffer
Low sensitivity	Improper storage of the ELISA kit	Store your standard at <-70 °C after reconstitution, others at 4 °C. Keep substrate solution protected from light
	Stop solution	Add stop solution to each well before reading plate

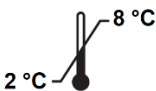

## 10. EXPLANATION OF SYMBOLS

	Catalogue number
	Batch code
	Caution
	Use by date
	Temperature limit
	Manufacturer
 <p data-bbox="256 1182 464 1205">www.biovendor.com</p>	Read electronic instructions for use - eIFU
	The content is sufficient for 96 tests
	Biological risks



12								
11								
10								
9								
8								
7								
6								
5								
4								
3								
2								
1								
	A	B	C	D	E	F	G	H

Example Version



**BioVendor – Laboratorní medicína a.s.**

Karásek 1767/1, 621 00 Brno, Czech Republic

+420 549 124 185

[info@biovendor.com](mailto:info@biovendor.com)

[sales@biovendor.com](mailto:sales@biovendor.com)

[www.biovendor.com](http://www.biovendor.com)

