

ENG

Instructions for Use:
HUMAN PHOSPHOTYROSINE
Tie-2 ELISA

Catalogue number:
REH012R

For research use only!

 **BioVendor**
R&D[®]



BioVendor – Laboratorní medicína a.s.

Karásek 1767/1, 621 00 Brno, Czech Republic

+420 549 124 185

info@biovendor.com

sales@biovendor.com

www.biovendor.com

1. INTRODUCTION	3
2. STORAGE, EXPIRATION	3
3. REAGENT SUPPLIED	3
4. MATERIAL REQUIRED BUT NOT SUPPLIED	4
5. SAMPLE PREPARATION	4
6. REAGENT PREPARATION	5
7. ASSAY PROCEDURE	6
8. ASSAY PROCEDURE - SUMMARY	6
9. TYPICAL DATA	7
10. TROUBLESHOOTING	8
11. EXPLANATION OF SYMBOLS	9

HISTORY OF CHANGES

Previous version	Current version
	ENG.001.A
New edition	

1. INTRODUCTION

The BioVendor Phosphotyrosine TIE-2 ELISA kit is a very rapid, convenient and sensitive assay kit that can monitor the activation or function of important biological pathways in cell lysates. By determining phosphorylated TIE-2 in your experimental model system, you can verify pathway activation in your cell lysates. You can simultaneously measure numerous different cell lysates without spending excess time and effort in performing a Western Blot analysis.

This sandwich-based ELISA kit is an in vitro enzyme-linked immunosorbent assay for the measurement of Human phospho-TIE-2. An anti-TIE-2 antibody has been coated onto a 96-well plate. Samples are pipetted into the wells and phosphorylated and unphosphorylated TIE-2 present in a sample is bound to the wells by the immobilized antibody. The wells are washed and biotinylated anti-phosphotyrosine antibody is used to detect only tyrosine-phosphorylated protein. After washing away unbound antibody, HRP-conjugated streptavidin is pipetted to the wells. The wells are again washed, a TMB substrate solution is added to the wells and color develops in proportion to the amount of phospho-TIE-2 bound. The Stop Solution changes the color from blue to yellow, and the intensity of the color is measured at 450 nm

2. STORAGE, EXPIRATION

The kit may be stored at 4°C for up to 6 months. For extended storage, it is recommended to store at -80°C. For prepared reagent storage, see table below.

3. REAGENT SUPPLIED

Component	Size / Description	Storage / Stability After Preparation
Pan TIE-2 Microplate (Item A)	96 wells (12 strips x 8 wells) coated with anti-pan-TIE-2	1 month at -20 °C*
Wash Buffer Concentrate (20X) (Item B)	25 ml of 20X concentrated solution	1 month at 4 °C
Positive Control-K5PVS001-1 (Item K)	1 vial of lyophilized powder from K562 cell lysates	1 week at -80°C
Biotinylated anti-phosphotyrosine (Item C)	2 vials of biotinylated anti-phosphotyrosine. Each vial is enough to assay half the microplate	5 days at 4°C
HRP-Streptavidin Concentrate (Item G)	1 vial (200 µl) of 300X concentrated HRP-conjugated streptavidin	Do not store and reuse
TMB One-Step Substrate Reagent (Item H)	12 ml of 3,3',5,5'-tetramethylbenzidine (TMB) in buffer solution	N/A
Stop Solution (Item I)	8 ml of 0.2 M sulfuric acid	N/A

Assay Diluent (Item E2)	15 ml of 5X concentrated buffer. For diluting cell lysate samples, detection antibody (Item C), and HRP-Streptavidin concentrate	1 month at 4 °C
Cell Lysate Buffer (Item J)	5 ml 2X cell lysis buffer (does not include protease and phosphatase inhibitors)	1 month at 4 °C

*Return unused wells to the pouch containing desiccant pack, reseal along entire edge.

4. MATERIAL REQUIRED BUT NOT SUPPLIED

- Microplate reader capable of measuring absorbance at 450 nm.
- Protease and Phosphatase inhibitors.
- Shaker.
- Precision pipettes to deliver 2 µl to 1 ml volumes.
- Adjustable 1-25 ml pipettes for reagent preparation.
- 100 ml and 1 liter graduated cylinders.
- Absorbent paper.
- Distilled or deionized water.
- Log-log graph paper or computer and software for ELISA data analysis.
- Tubes to prepare the positive control or sample dilutions.

5. SAMPLE PREPARATION

5.1 Cell Lysate Preparation

Rinse the cells with PBS, making sure to remove any remaining PBS before adding the lysis buffer. Solubilize cells at 4×10^7 cells/ml in prepared Cell Lysate Buffer (Item J) (see Reagent Preparation step 3). Pipette up and down to resuspend the pellet. Incubate the lysates with shaking at 2-8°C for 30 minutes. Microcentrifuge at 13,000 rpm for 10 minutes at 2-8°C and transfer the supernatantes into a clean test tube. Lysates should be used immediately or aliquoted and stored at -70°C. Avoid repeated freeze-thaw cycles. Thawed lysates should be kept on ice prior to use.

For the initial experiment, we recommend a serial dilution, such as a 5-fold to 100fold dilution, for your cell lysates with prepared Assay Diluent (Item E2) (see Reagent Preparation step 2) before use.

Note: The fold dilution of sample used depends on the abundance of phosphorylated proteins and should be determined empirically. More of the sample can be used if signals are too weak. If signals are too strong, the sample can be diluted further.

6. REAGENT PREPARATION

1. Bring all reagents and samples to room temperature (18 – 25°C) before use.
2. 5X Assay Diluent (Item E2) should be diluted 5-fold with deionized or distilled water before use.
3. Cell lysate buffer (Item J) should be diluted 2-fold with deionized or distilled water (for cell lysate and tissue lysate). We also recommend the addition of protease and phosphatase inhibitors (not included) to the lysis buffer prior to use.
4. Preparation of Positive Control: Briefly spin the Positive Control Vial (Item K). Add 400 μ l of prepared 1X Assay Diluent (Item E2) into Item K to prepare a Positive Control Stock Solution. Gently mix the powder to allow it to dissolve thoroughly. If a precipitate is seen in the solution after mixing, this can be removed by a quick centrifuge of the positive control vial, and then pipetting the supernatant only for the assay. Add 15 μ l of the prepared Positive Control Stock Solution from the vial of Item K into a tube with 435 μ l 1X Assay Diluent to prepare Positive Control (P-1). Pipette 300 μ l 1X Assay Diluent into each tube. Use the Positive Control (P-1) solution to produce a dilution series (shown below). Mix each tube thoroughly before the next transfer. 1X Assay Diluent serves as the blank (P-0).

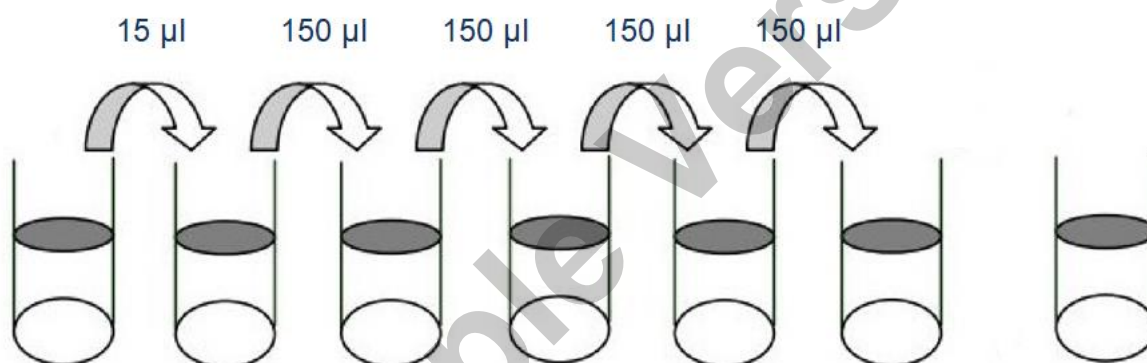

	Stock	P-1	P-2	P-3	P-4	P-5	Blank (P-0)
Diluent volume	Item K+ 400 μ l	435 μ l	300 μ l	300 μ l	300 μ l	300 μ l	300 μ l

5. If the Wash Concentrate (20X) (Item B) contains visible crystals, warm to room temperature and mix gently until dissolved. Dilute 20 ml of Wash Buffer Concentrate into deionized or distilled water to yield 400 ml of 1X Wash Buffer.
6. Preparation of Biotinylated anti-phosphotyrosine: Briefly spin the vial of Biotinylated anti-phosphotyrosine (Item C). Add 100 μ l of 1X Assay Diluent into the vial to prepare a phosphotyrosine detection antibody concentrate. Pipette up and down to mix gently (the concentrate can be stored at 4°C for 5 days or at -80°C for one month). The concentrate should then be diluted 80-fold with 1X Assay Diluent and used in step 4 of the Assay Procedure.
7. Preparation of HRP-Streptavidin: Briefly spin the vial of HRP-Streptavidin concentrate (Item G) before use. HRP-Streptavidin should be diluted 300-fold with 1X Assay Diluent and used in step 7 of the Assay Procedure.

For example: Briefly spin the vial (Item G) and pipette up and down to mix gently. Add 40 μ l of HRP-Streptavidin concentrate into a tube with 12 ml 1x Assay Diluent to prepare a 300-fold diluted HRP Streptavidin solution (don't store the diluted solution for next day use). Mix well.

7. ASSAY PROCEDURE

1. Bring all reagents and samples to room temperature (18 - 25°C) before use. It is strongly recommended to run all positive controls and samples in at least duplicate.
2. Label removable 8-well strips as appropriate for your experiment.
3. Add 100 µl of positive control (see Reagent Preparation step 4) or sample into appropriate wells. Cover the wells and incubate for 2.5 hours at room temperature or overnight at 4°C with gentle shaking.
4. Discard the solution and wash 4 times with 1X Wash Solution. Wash by filling each well with Wash Buffer (300 µl) using a multi-channel Pipette or autowasher. Complete removal of liquid at each step is essential for good performance. After the last wash, remove any remaining Wash Buffer by aspirating or decanting. Invert the plate and blot it against clean paper towels.
5. Add 100 µl of prepared 1X biotinylated anti-phosphotyrosine (see Reagent Preparation step 6) to each well. Incubate for 1 hour at room temperature with gentle shaking.
6. Discard the solution. Repeat the wash as in step 4.
7. Add 100 µl of prepared HRP-Streptavidin solution (see Reagent Preparation step 7) to each well. Incubate for 45 minutes at room temperature with gentle shaking.
8. Discard the solution. Repeat the wash as in step 4.
9. Add 100 µl of TMB One-Step Substrate Reagent (Item H) to each well. Incubate for 30 minutes at room temperature in the dark with gentle shaking.
10. Add 50 µl of Stop Solution (Item I) to each well. Read at 450 nm immediately.

8. ASSAY PROCEDURE - SUMMARY

1. Prepare all reagents, samples and positive control as instructed.
2. Add 100 µl positive control or sample to each well. Incubate 2.5 hours at room temperature or overnight at 4°C with gentle shaking.
3. Add 100 µl prepared detection antibody to each well. Incubate for 1 hour at room temperature with gentle shaking.
4. Add 100 µl prepared HRP-Conjugated solution. Incubate for 45 minutes at room temperature with gentle shaking.
5. Add 100 µl TMB One-Step Substrate Reagent to each well. Incubate 30 minutes at room temperature.
6. Add 50 µl Stop Solution to each well. Read at 450 nm immediately.

9. TYPICAL DATA

Calculate the mean absorbance for each set of duplicate positive controls and samples, and then subtract the average zero (blank) optical density.

9.1 Positive Control

K562 cells were treated with Pervanadate at 37°C for 10 min. Cells were solubilized at 4×10^7 cells/ml in lysis buffer. Serial dilutions of lysates were analyzed in this ELISA (see Reagent Preparation step 4).

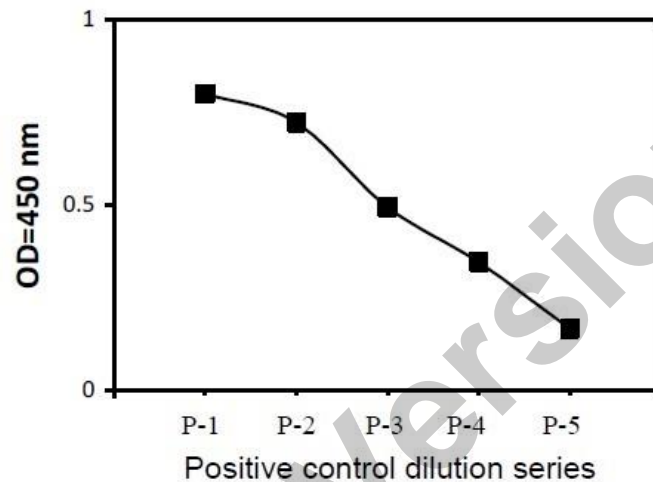

9.2 Pervanadate Stimulation of HUVEC Cell Line



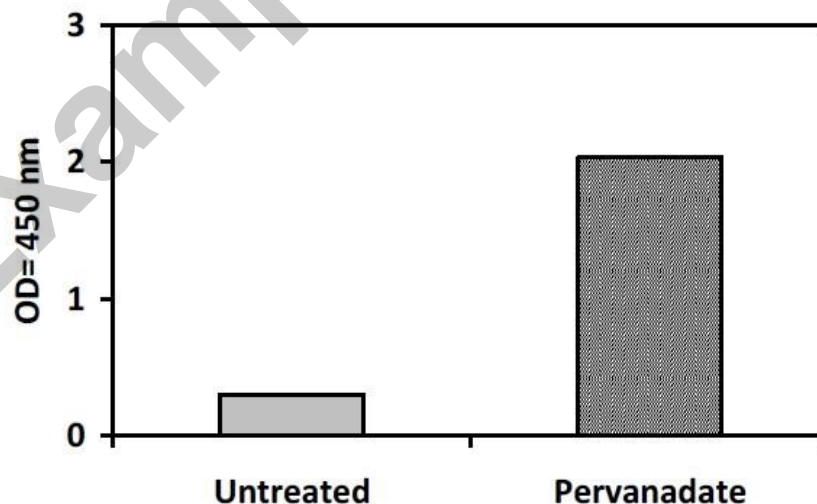





HUVEC cells were untreated or treated with Pervanadate for 10 min at 37°C. Cell lysates were analyzed using this phosphoELISA:

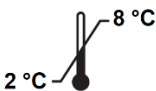

10. TROUBLESHOOTING

Problem	Cause	Solution
Low signal in samples	Sample concentration is too low	Increase sample concentration
	Improper preparation of detection antibody	Briefly spin down vials before opening. Dissolve the powder thoroughly.
	Too brief incubation times	Ensure sufficient incubation time. Assay procedure step 3 may be done overnight
	Inadequate reagent volumes or improper dilution	Check pipettes and ensure correct preparation
High signal in samples	Sample concentration is too high	Reduce sample concentration
Large CV	Inaccurate pipetting	Check pipettes
	Air bubbles in wells	Remove bubbles in wells
High background	Plate is insufficiently washed	Review the manual for proper wash. If using a plate washer, ensure that all ports are unobstructed
	Contaminated wash buffer	Make fresh wash buffer
Low sensitivity	Improper storage of the ELISA kit	Store your positive control at $<-70^{\circ}\text{C}$ after reconstitution, others at 4°C . Keep substrate solution protected from light
	Stop solution	Add stop solution to each well before reading plate
	Improper primary or secondary antibody dilution	Ensure correct dilution

11. EXPLANATION OF SYMBOLS

	Catalogue number
	Batch code
	Caution
	Use by date
	Temperature limit
	Manufacturer
 www.biovendor.com	Read electronic instructions for use - eIFU
	The content is sufficient for 96 tests
	Biological risks

1								
2								
3								
4								
5								
6								
7								
8								
9								
10								
11								
12								
	A	B	C	D	E	F	G	H

Example Version



BioVendor – Laboratorní medicína a.s.

Karásek 1767/1, 621 00 Brno, Czech Republic

+420 549 124 185

info@biovendor.com

sales@biovendor.com

www.biovendor.com



FOLLOW US